

Typ TKF... L

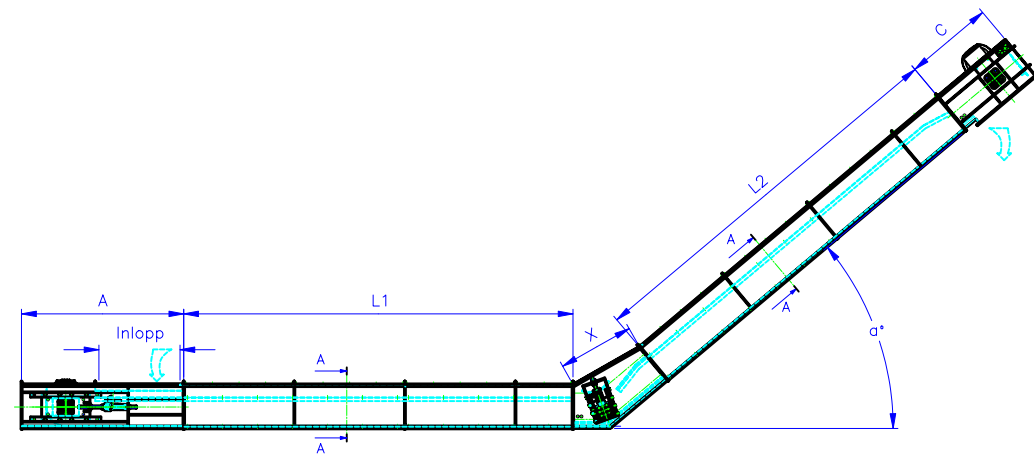

Typ TKF... LB

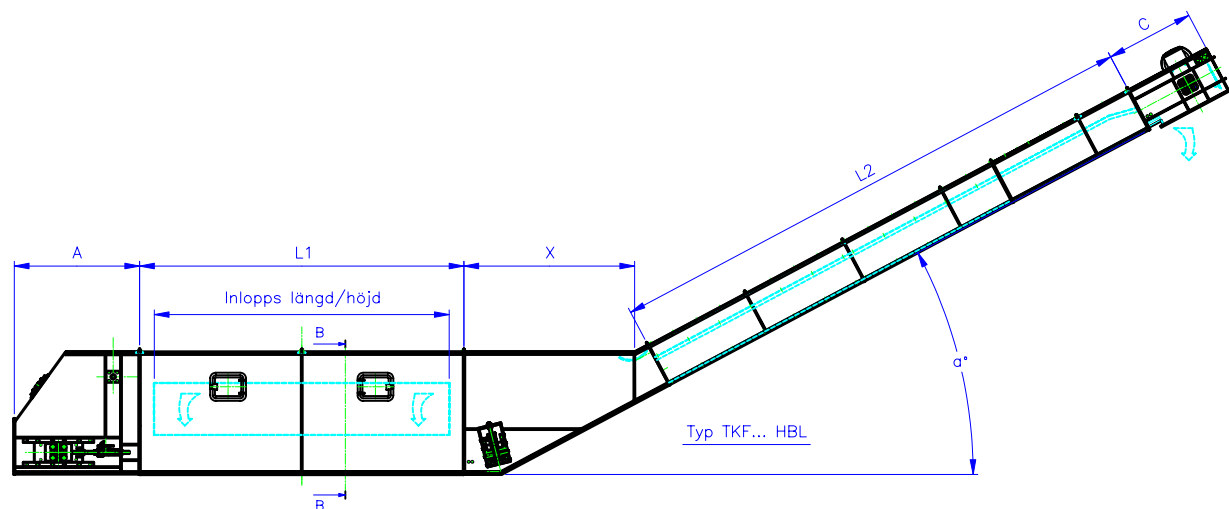

Typ TKF... HBL

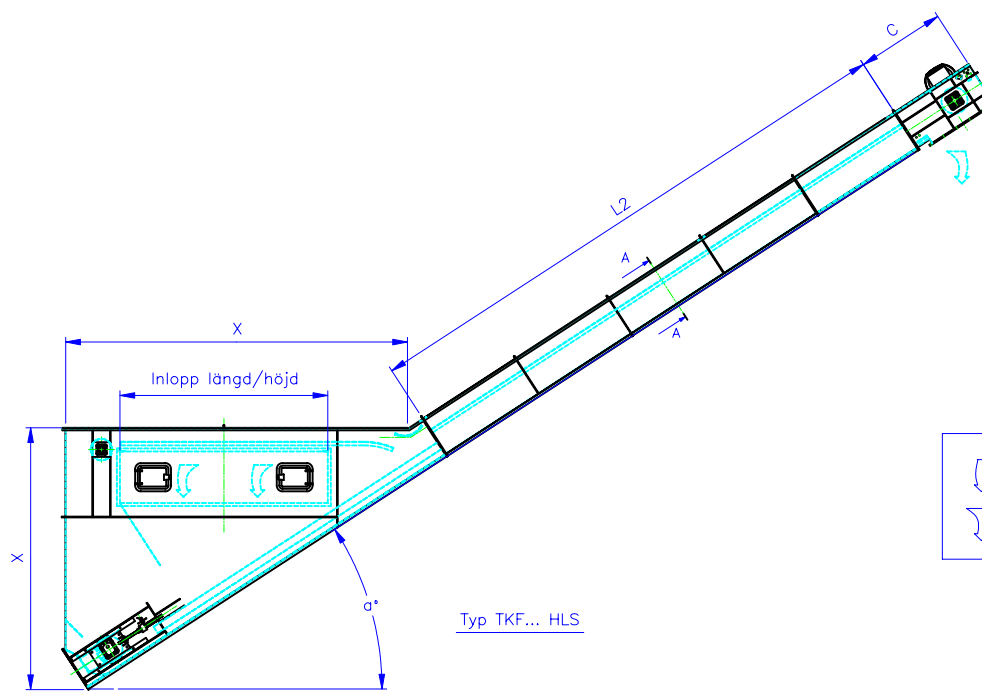

Typ TKF... HLS

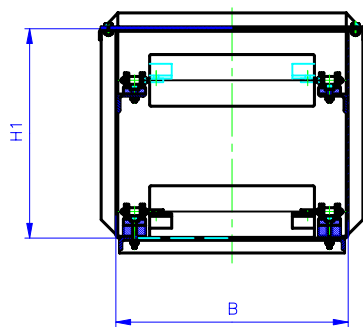
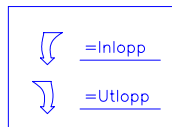

Snitt A-A
Typ: TKF... L & LB

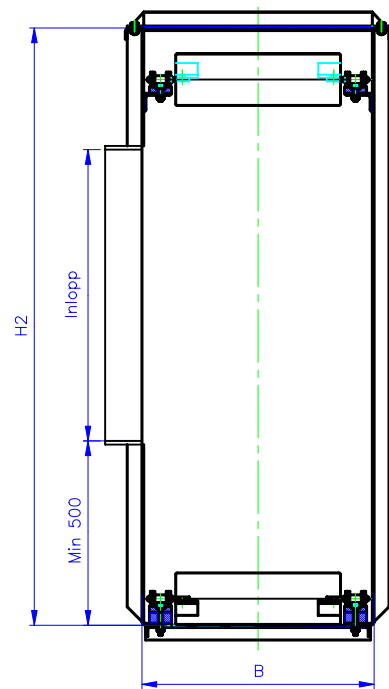

Snitt B-B
Typ: TKF...HBL

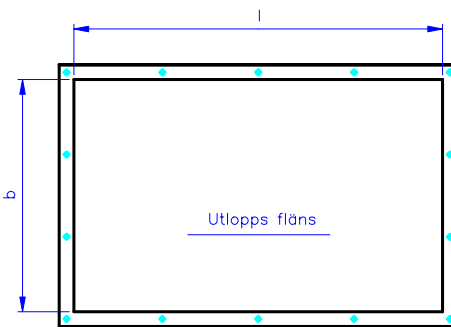

TKF:	630	800	1000	1200	1550
A:	2200	2200	2200	2200	2400
B:	630	800	1000	1200	1550
C:	1200	1200	1400	1400	1600
L1:	X	X	X	X	X
L2:	X	X	X	X	X
H1 (typ L&LB):	568	677	838	890	910
H2 (typ HBL):	1600	1700	1800	1900	2000
alpha:	0-45°	0-45°	0-45°	0-45°	0-45°
Inlopp max inv. lxb (typ L&LB):	1100x460	1100x630	1100x800	1100x1000	1300x1200
Inlopp (typ HBL&HLS):	X	X	X	X	X
Utlopp (inv. lxb):	1000x630	1000x800	1200x1000	1200x1200	1400x1550
X: Mått anpassade efter applikation					

Denna ritning är ett tekniskt dokument och ska inte användas för tillverkning utan tillstånd från Saxlund. För ytterligare information kontakta Saxlund.

		BOX 79, S-137 22 Västerhaninge TELEPHONE INT +46 8 504 105 80 TELEFAX INT +46 8 504 105 99						
		Saxlund standard Skraptransportörs utföranden. TKF630-1550 L, LB, HBL & HLS						
REPLACED OF	APP	CHD	DWN	SCALE	1:50	DATE	050310	1-E-810